



GREWIN INDUSTRIAL GROUP CO.,LTD.

TEL/WhatsApp: +86 18622096679

Mail: admin@coilwindingmachinechina.com

Web:www.coilwindingmachinechina.com



GW-900A Coil turns tester

Operation Manual

Chapter 1 Essentials

1.1 Introduction

Coil turns tester is an equipment of good quality and low price, used to test all kinds of magnetic coil turns. Featuring strong functions, outstanding performance and easy operation, the equipment meets the needs of high-precision testing and productive spot high- speed testing.

1.2 Principle Sketch

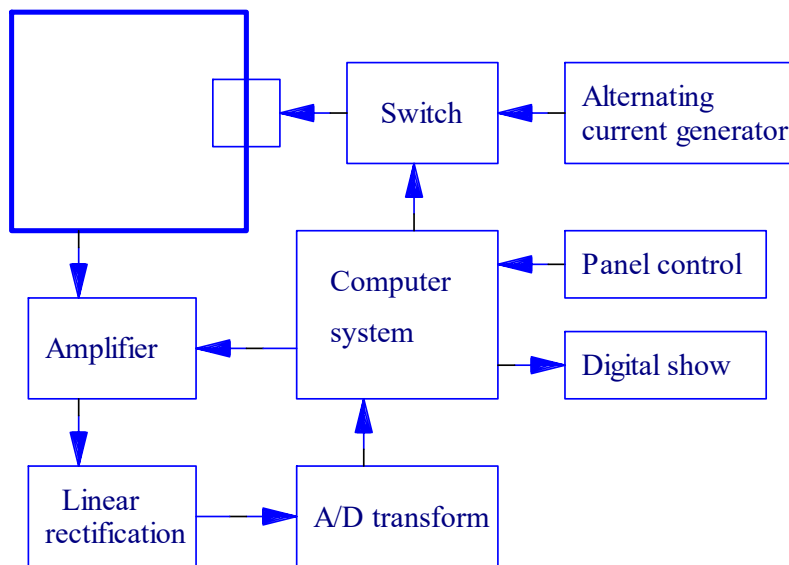

1.3 Technology Index

- 1.3.1 Testing range: 0---20000 turns
- 1.3.2 Testing precision: 0.1%
- 1.3.3 Testing speed: twice/sec
- 1.3.4 Testing frequency: 10kHz,2kHz,200Hz
- 1.3.5 Coil dimensions: internal diameter>3mm, external diameter≤90mm (can be made to special measure)
- 1.3.6 Choice function: absolute error choice and percentage error choice

GREWIN INDUSTRIAL GROUP CO.,LTD.

Add: The fourth floor A-A3 zone aviation business area,Dongli Distr,Tianjin,China.



GREWIN INDUSTRIAL GROUP CO.,LTD.

TEL/WhatsApp: +86 18622096679

Mail: admin@coilwindingmachinechina.com

Web:www.coilwindingmachinechina.com



WhatsApp



WeChat

1.4 Operating Conditions

1.4.1 Condition temperature and humidity

The accuracy can be achieved when temperature is between 10 °C and 30** ,
humidity $\leq 80\%RH$.

The equipment can be operated when the temperature is between 0** and 40** ,
humidity $\leq 90\%RH$.

1.4.2 Power supply

Voltage: AC 220V $\pm 10\%$

Frequency: 50Hz $\pm 5\%$

Power: $\leq 30W$

1.4.3 Volume

Main equipment: 390*160*420 (width*height*depth)

Testing equipment: 185*150mm (diameter*height)

1.4.4 Weight

Main equipment: 5kg

Testing equipment: 1kg

1.5 External Structure

1.5.1 Testing equipment

1.5.1.1 Sketch map

GREWIN INDUSTRIAL GROUP CO.,LTD.

Add: The fourth floor A-A3 zone aviation business area,Dongli Distr,Tianjin,China.



GREWIN INDUSTRIAL GROUP CO.,LTD.

TEL/WhatsApp: +86 18622096679

Mail: admin@coilwindingmachinechina.com

Web:www.coilwindingmachinechina.com

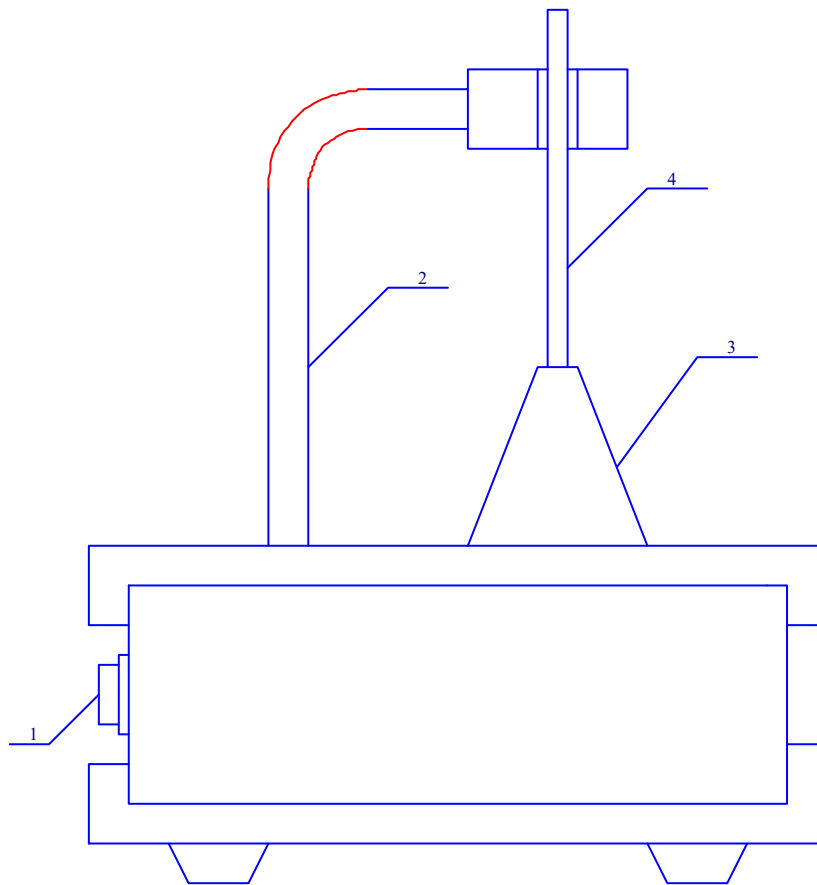

1.5.1.2 Illustration

1.5.1.3 Illustration

Number	Name	Function Illustration
1	Socket	Connect with the main equipment with the five-wired electric cable to provide testing signal.
2	Auxiliary stick	During testing, turn the auxiliary stick into close contact with the main stick.
3	Awl support	Fix the coil to surround the main stick and reduce the error caused by the position of the coil.
4	Main stick	Put the coil around the main stick and contact the awl support horizontally to reduce the error.

1.5.2 Front panel

1.5.2.1 Sketch map

GREWIN INDUSTRIAL GROUP CO.,LTD.

Add: The fourth floor A-A3 zone aviation business area,Dongli Distr,Tianjin,China.



GREWIN INDUSTRIAL GROUP CO.,LTD.

TEL/WhatsApp: +86 18622096679

Mail: admin@coilwindingmachinechina.com

Web:www.coilwindingmachinechina.com

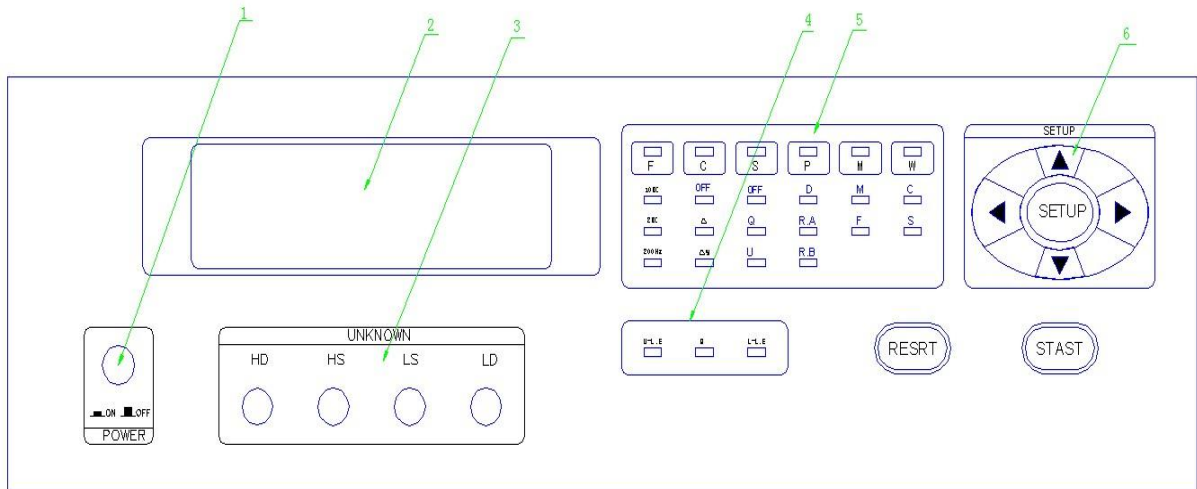

1.5.2.2 Illustration

序号	Name	Function Illustration
1	Switch	“ON” to have the power supply and “OFF” to switch off.
2	Testing end	Provide four-end testing. HD,HS are connected to one end of the coil; LD,LS are connected to the other end of the coil.
3	Keyboard	To choose the functions.
4	Function instruction	To indicate the different functions.
5	Screen	The testing result and the function instructions show on the screen.

1.5.3 Back panel

1.5.3.1 Sketch map

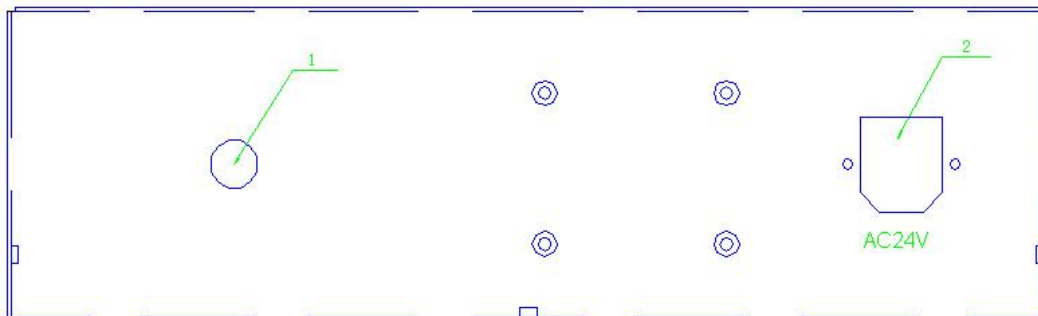

1.5.3.2 Illustration

GREWIN INDUSTRIAL GROUP CO.,LTD.

Add: The fourth floor A-A3 zone aviation business area,Dongli Distr,Tianjin,China.



GREWIN INDUSTRIAL GROUP CO.,LTD.

TEL/WhatsApp: +86 18622096679

Mail: admin@coilwindingmachinechina.com

Web:www.coilwindingmachinechina.com



Number	Name	Function Illustration
1	Socket	Connect with the main equipment with the five-wired electric cable to provide testing signal.。
2	Power supply socket	Connect with 24V,60Hz alternating current.

Chapter 2 Operation Instructions

The instrument resumes the last measurement state automatically when it is turned on. All the functions of the measurement show on the panel and can be got through the four buttons “”, “”, “”, “”. The indicator lamp of a function shines when pressing “”, “” to the function you need, then the parameters of the function can be chosen by pressing 上下 to where the indicator lamp shines.

Functions:

- A. F---Frequency: 10kHz, 2kHz,200Hz
- B. C---Choice: Off, Absolute error (Δ), Percentage error ($\Delta\%$)
- C. S---Sound: Off, Qualified (Q), Unqualified (U)
- D. P---Parameter: Read directly(D), Rectification A(R.A.), Rectification B (R.B.)
- E. M---Measurement Range: Turns more than 1000 (M), Turns fewer than 500 (F)
- F. W---Way: Continuous, Single

2.1 Measurement

- 2.1.1 Connect the testing equipment with the main equipment using five-wired electric cable, and connect the clip-wires with the main equipment.
- 2.1.2 Plug the wire into the jack at the back of the instrument, and press POWER.
- 2.1.3 Press RESET to the measurement state at any time.
- 2.1.4 Choose the testing method by pressing “”, “”, “”, “”. (See details in 2.2)
- 2.1.5 Put the magnetic-ring coil around the main stick; turn the auxiliary stick into close contact with the main stick.
- 2.1.6 Connect the two end lines of the tested coil using the clip-wires.
- 2.1.7 The number of the coil turns shows on the screen.

2.2 Function Instructions

GREWIN INDUSTRIAL GROUP CO.,LTD.

Add: The fourth floor A-A3 zone aviation business area,Dongli Distr,Tianjin,China.



GREWIN INDUSTRIAL GROUP CO.,LTD.

TEL/WhatsApp: +86 18622096679

Mail: admin@coilwindingmachinechina.com

Web:www.coilwindingmachinechina.com



2.2.1 Testing Frequency

Three frequencies (10kHz, 2kHz, 200Hz) can be chosen. To get best testing effect, suitable frequency should be chosen according to the kind of coil.

2.2.2 Parameter

Generally, the testing result of coil of high magnetic permeability is stable and accurate. While the result might be inaccurate when the coil is of low magnetic permeability or the coil winding is unequal, but the result can be rectified by the following ways:

a. Read Directly

The turns number can be read directly.

b. Rectification A







This rectification can be used when the result is inaccurate and the coil has one winding. 40 coil turns storage cells are provided, each one can store the rectifications of a show value. And the Choice function is done according to the show value. (See details in 2.2.4.1)

c. Rectification B







This rectification can be used when the result is inaccurate and the coil has two windings. 20 coil turns storage cells are provided, each one can store the rectifications of the show values of the two windings. And the Choice function is done according to one of the standard value. (See details in 2.2.4.2)

The storage cells and the rectifications won't be lost because of power break.

2.2.2.1 Rectification A

- Press “” or “” to where the Parameter lamp shines.
- Press “” or “” to where Rectification A shines.
- Press SET-UP, “-a-xx” shows (xx is flash, the number is between 00 and 39.).
- Press “” or “” to set the number of the storage cell, then press SET-UP.
- Repeat 2.2.2.1.d and 2.2.2.1.e to rectify the show value to the coil turns number. Note that the rectification can not exceed +/-20% of the directly-read number, otherwise ERROR shows.
- Press SET-UP or START, the rectified number will be stored in the xx storage cell and coil turns testing can start.

2.2.2.2 Rectification B

- Press “” or “” to where the Parameter lamp shines.
- Press “” or “” to where Rectification B shines.
- Press SET-UP, “-b-xx” shows (xx is flash, the number is between 00 and 19.).
- Press “” or “” to set the number of the storage cell, then press SET-UP. “-B-1” shows and the rectification of the first winding starts.

GREWIN INDUSTRIAL GROUP CO.,LTD.

Add: The fourth floor A-A3 zone aviation business area,Dongli Distr,Tianjin,China.



GREWIN INDUSTRIAL GROUP CO.,LTD.

TEL/WhatsApp: +86 18622096679

Mail: admin@coilwindingmachinechina.com

Web:www.coilwindingmachinechina.com



WhatsApp



WeChat

- e. Repeat 2.2.2.1.d and 2.2.2.1.e to rectify the show value to the coil turns number.
- f. Press SET-UP, “-B-2” shows. The rectification of the second winding starts.
- g. Connect the two end lines of the second winding using the clip-wires.
- h. Repeat 2.2.2.1.d and 2.2.2.1.e to rectify the show value to the coil turns number.
- i. Press SET-UP or START, the rectified number will be stored in the xx storage cell and coil turns testing can start.

Note: When Rectification B is used, the turns of two windings should differ from each other. The rectification can not exceed +/-40% of the directly-read number, otherwise ERROR shows.

2.2.3 Measurement Range

Generally, parameter M is chosen when the coil turns are more than 1000, and F is chosen when the turns are fewer than 500. Either of them can be chosen when the turns are between 500 and 1000.

2.2.4 Way

a. Continuous Measurement way

The instrument continuously measure, calculate and show the coil turns.

The latter measurement goes immediately after the former one.

b. Single Measurement Way

The latter measurement goes only after START is pressed after the former one is done.

Chapter 3 The Whole Set and Quality Guarantee

3.1 The Whole Set

The whole set includes : (each is of one piece)

1. Magnetic coil turns tester
2. Clip-wire
3. Electric wire
4. Five-wired electric cable
5. Operation manual
6. Certification

Please contact our factory or sales point immediately after finding something is missing.

GREWIN INDUSTRIAL GROUP CO.,LTD.

Add: The fourth floor A-A3 zone aviation business area,Dongli Distr,Tianjin,China.



GREWIN INDUSTRIAL GROUP CO.,LTD.

TEL/WhatsApp: +86 18622096679

Mail: admin@coilwindingmachinechina.com

Web:www.coilwindingmachinechina.com



WhatsApp



WeChat

3.2 Quality Guarantee

The guarantee period: 18 months. The period starts from the delivering day when the equipment is bought from our company or the sales point. During the period, the maintenance cost is paid by the customer if the damage is due to improper operation of the user or external force.

The lifelong maintenance of the equipment is done by our company.

Chapter 3 The Whole Set and Quality Guarantee

3.1 The Whole Set

The whole set includes : (each is of one piece)

7. Magnetic coil turns tester
8. Clip-wire
9. Electric wire
10. Five-wired electric cable
11. Operation manual
12. Certification

Please contact our factory or sales point immediately after finding something is missing.

3.2 Quality Guarantee

The guarantee period: 18 months. The period starts from the delivering day when the equipment is bought from our company or the sales point. During the period, the maintenance cost is paid by the customer if the damage is due to improper operation of the user or external force.

The lifelong maintenance of the equipment is done by our company.

GREWIN INDUSTRIAL GROUP CO.,LTD.

Add: The fourth floor A-A3 zone aviation business area,Dongli Distr,Tianjin,China.